



Models:

24S

28S

24SR

Instructions for the installer



Boiler installation and commissioning tips



- ✔ Do not forget to remove the transit caps and plugs from the boiler connections these are fitted to every boiler.
- ✔ Keep the boiler clear of dust during installation and in particular do not allow any dust or debris to enter the top of the boiler where the flue connection is made. It is recommended that you put a dust sheet over the top of the boiler until you are ready to make the flue connection.
- ✔ Because every boiler is fired and tested live at the factory, a small amount of water remains within the boiler. It is possible for this water to initially cause the pump to seize. It is therefore recommended that the pump rotor be manually turned to free its rotation before turning the boiler on.
- ✔ Remember to release the auto air purge before filling the boiler. See the instructions to identify the location of this device.
- ✔ Do not remove the cap of the pressure test point of the air switch (top right side of the boiler).
- ✔ You are strongly advised to flush out the system both cold and hot in order to remove system and installation debris.
- ✔ It is also sensible to initially fire and commission the boiler before connecting any external controls such as a room thermostat. By this method if you have a subsequent problem following the addition of an external control you can eliminate the boiler from your fault analysis.
- ✔ Do not forget to range rate the boiler to suit the system requirements. This procedure is covered in the commissioning section of the installation manual.
- ✔ If the boiler is fitted with a digital programmer, when setting the times for automatic operation, remember that for every “ON” time there must be an “OFF” time to follow and that on every occasion you enter a time you must also indicate which days that you want the boiler to follow the timed settings.
- ✔ Some products incorporate an anti cycling time delay. It is normal when first switching the boiler on for the boiler to operate on heating for a few seconds then switch off. After 3–4 minutes has elapsed the boiler will then re ignite and operate perfectly normally. The ignition delay cycle does not prevent normal operation of the boiler to provide domestic hot water.
- ✔ If you are in any doubts as to the installation or operation of the boiler please read the instruction manuals thoroughly and then if necessary contact Biasi UK for advice and assistance.

Important

The manual...

must be read thoroughly, so that you will be able to use the boiler in a safe and sensible way;

must be carefully kept. It may be necessary for reference in the future.

Installation...

must be carried out by a qualified person who will be responsible for observing the current Regulations.

First lighting up...

must be carried out by a competent and responsible person; the guarantee is valid from the date it is carried out.

Repairs...

(under guarantee)

must be carried out only by a competent and responsible person, using genuine spare parts. Thus do no more than switching off the boiler yourself (see the instructions).

Your boiler...

allows heating up of water to a temperature less than the boiling point;

must be connected to a central heating system and/or a hot water supply system, compatible with its performance and output;

can be used only for those purposes for which it has been specially designed;

must not be touched by children or by those unfamiliar with its operation;

must not be exposed to the elements.

The manufacturer...

disclaim all liability for any translations of the present manual from which incorrect interpretation may occur;

accepts no responsibility for unsatisfactory performance of the appliance and flue due to failure to comply the following instructions.

TABLE OF CONTENTS

1	General	2	4	Commissioning	20
1.1	Overview	2	4.1	Electrical installation	20
1.2	Combined control panel	3	4.2	Gas supply installation	20
1.3	Heating only control panel	3	4.3	Filling the D.H.W. system	20
1.4	Main diagram 24S, 28S	4	4.4	Initial filling of the system	20
1.5	Main diagram 24SR	5	4.5	Lighting the boiler	21
			4.6	Checking the gas pressure at the burner	21
2	General requirements	13	4.7	Checking the flue system	22
1.6	Technical data mod. 24S	6	4.8	Checking the ignition device	22
1.7	Technical data mod. 28S	8	4.9	Adjusting the burner ignition	22
1.8	Technical data mod. 24SR	10	4.10	Adjustment of useful central heating output	23
1.9	Hydraulic specifications	12	4.11	Instructing the user	24
1.10	Expansion tank	12			
2.1	Related documents	13	5	Gas conversion	25
2.2	Location of appliance	13	5.1	Warnings	25
2.3	Flue system	13	5.2	Procedures	25
2.4	Gas supply	13	6	Maintenance	26
2.5	Air supply	14	6.1	Warnings	26
2.6	Ventilation	14	6.2	Dismantling the external panels	26
2.7	Water circulation (central heating)	14	6.3	Emptying the domestic hot water system (Combination boilers only)	26
2.8	Domestic water	15	6.4	Emptying the central heating system	27
2.9	Electrical supply	15	6.5	Cleaning the primary heat exchanger	27
			6.6	Checking the pressurisation in the expansion tank	27
3	Installation	16	6.7	Cleaning the burner	27
3.1	Warnings	16	6.8	Checking the exhaust duct	27
3.2	Precautions for installation	16			
3.3	Installing the bracket	17			
3.4	Mounting the boiler	17			
3.5	Fitting the exhaust fume duct	17			
3.6	Electrical connections	18			
3.7	Frost protection	19			
3.8	Overall dimensions	19			
3.9	Joints	19			

Symbols used in the descriptions:

Combi = 24S, 28S

24 = 24S, 24SR

Central heating = 24SR

28 = 28S

This appliance conforms with the EEC directive 90/396 and, consequently, it has the right to make use of the  brand name

Moreover, the appliance conforms with the EEC directive 87/308 relative to the prevention and elimination of radio disturbances.

The appliance is built to comply with the regulation now in force regarding gas appliance's safety and the European regulation now in force relative to safety of household and similar electrical appliances.

The manufacturer, in the continuous process to improve his products, reserves the right to modify the data expressed in the present documentation at any time and without prior notice.

The present documentation is an informative support and it cannot be considered as a contract towards third parties.

1 GENERAL

1.1 Overview

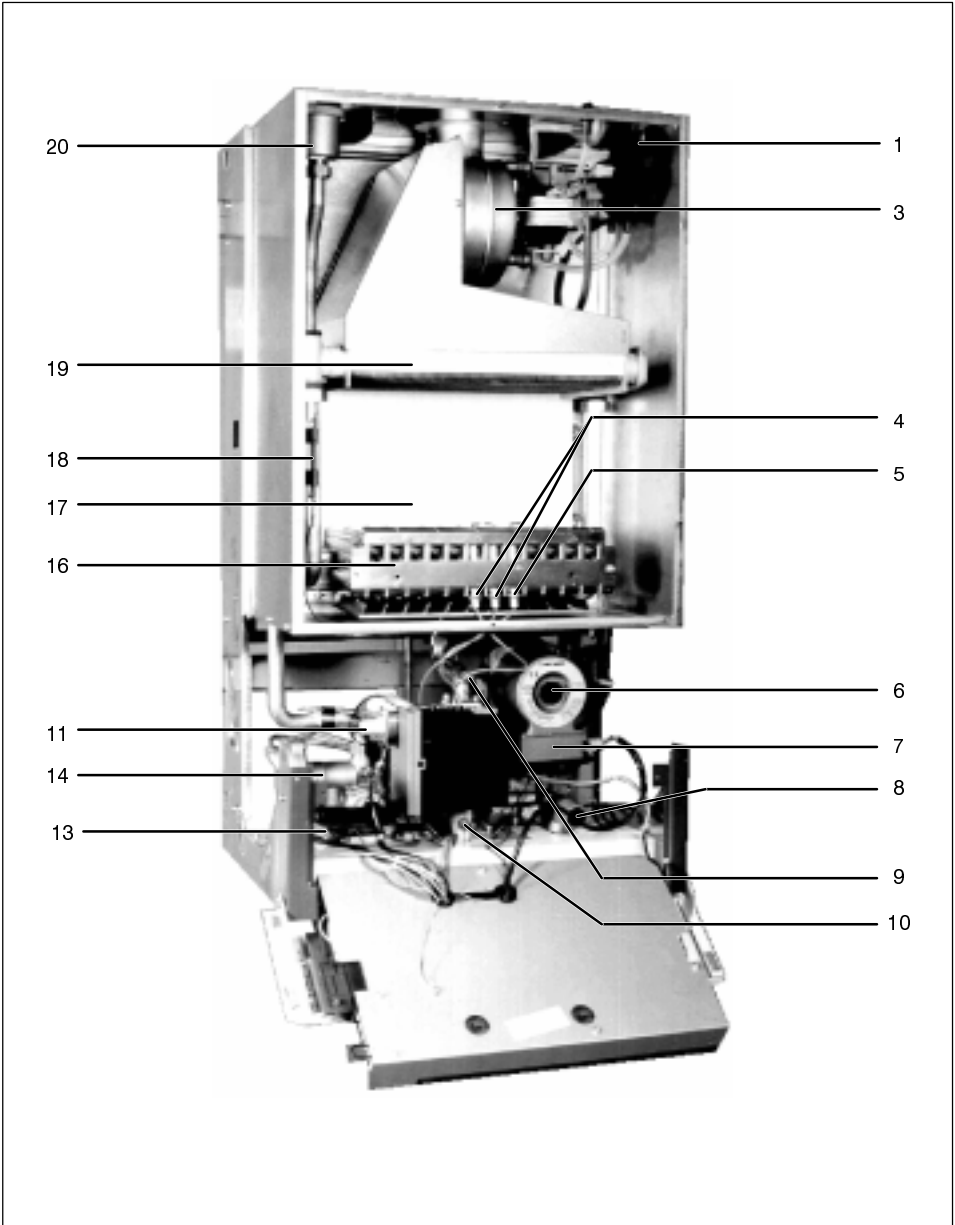

fig. 1.1

General

- 1 Air pressure switch
- 2 Venturi device
- 3 Fan
- 4 Ignition electrodes
- 5 Flame–detecting electrode
- 6 Pump vent plug
- 7 Pump
- 8 3 bar pressure relief valve
- 9 Gas valve outlet pressure tap
- 10 Gas valve inlet pressure tap
- 11 Modulation operator
- 12 Modulation gas valve
- 13 Main circuit drain cock
- 14 Three–way diverter valve
- 15 Three–way diverter valve body
- 16 Burner
- 17 Combustion chamber
- 18 Safety thermostat
- 19 Primary heat exchanger
- 20 Automatic bleed valve
- 21 Domestic hot water flow switch
- 22 Central heating flow switch
- 23 Domestic hot water probe NTC
- 24 Central heating probe NTC
- 25 Domestic hot water heat exchanger
- 26 By–pass
- 27 Expansion tank
- 28 Central heating flow cock
- 29 Domestic hot water outlet pipe
- 30 Gas cock
- 31 Domestic cold water inlet cock
- 32 Central heating return cock
- 33 Flue outlet pipe
- 34 Air intake pipe

1.2 Combined control panel

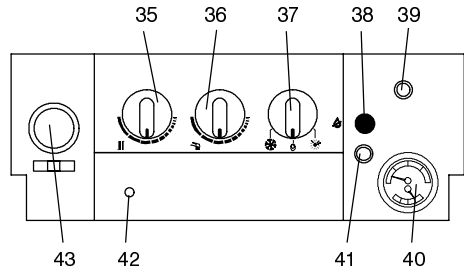

fig. 1.2

1.3 Heating only control panel

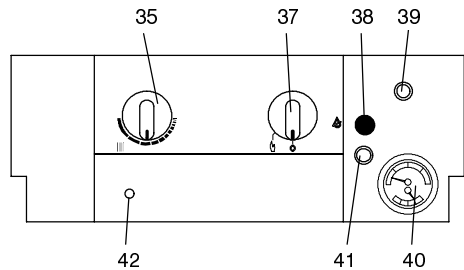

fig. 1.3

- 35 Central heating temperature adjustment knob
- 36 Domestic hot water temperature adjustment knob
- 37 Function switch
- 38 Lock–out signal lamp
- 39 Safety thermostat reset button
- 40 Central heating circuit temperature and pressure gauge
- 41 Boiler reset button
- 42 “Appliance ON” Led
- 43 Time switch (central heating control)

1.4 Main diagram 24S, 28S

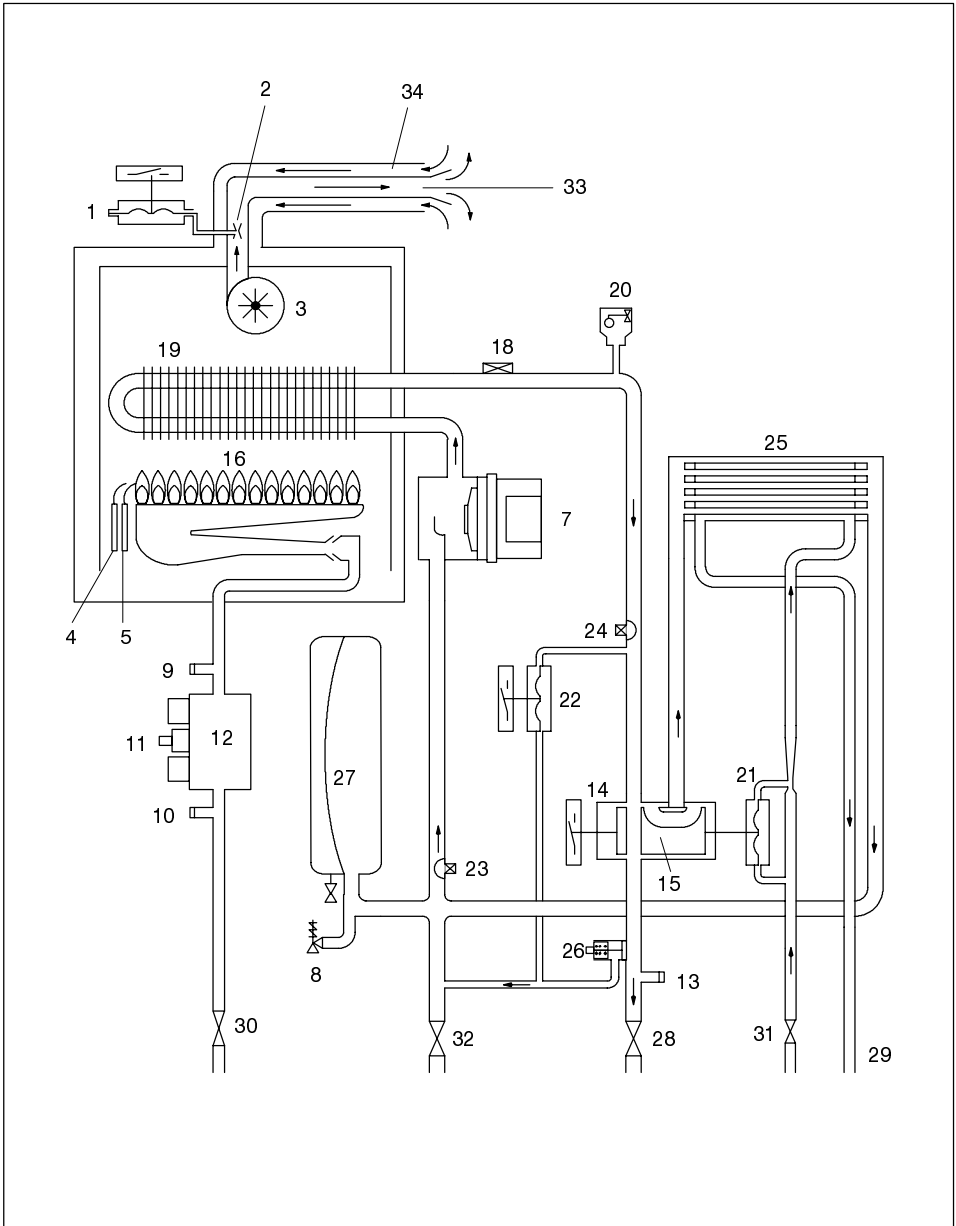

fig. 1.4 (key on page 3)

1.5 Main diagram 24SR

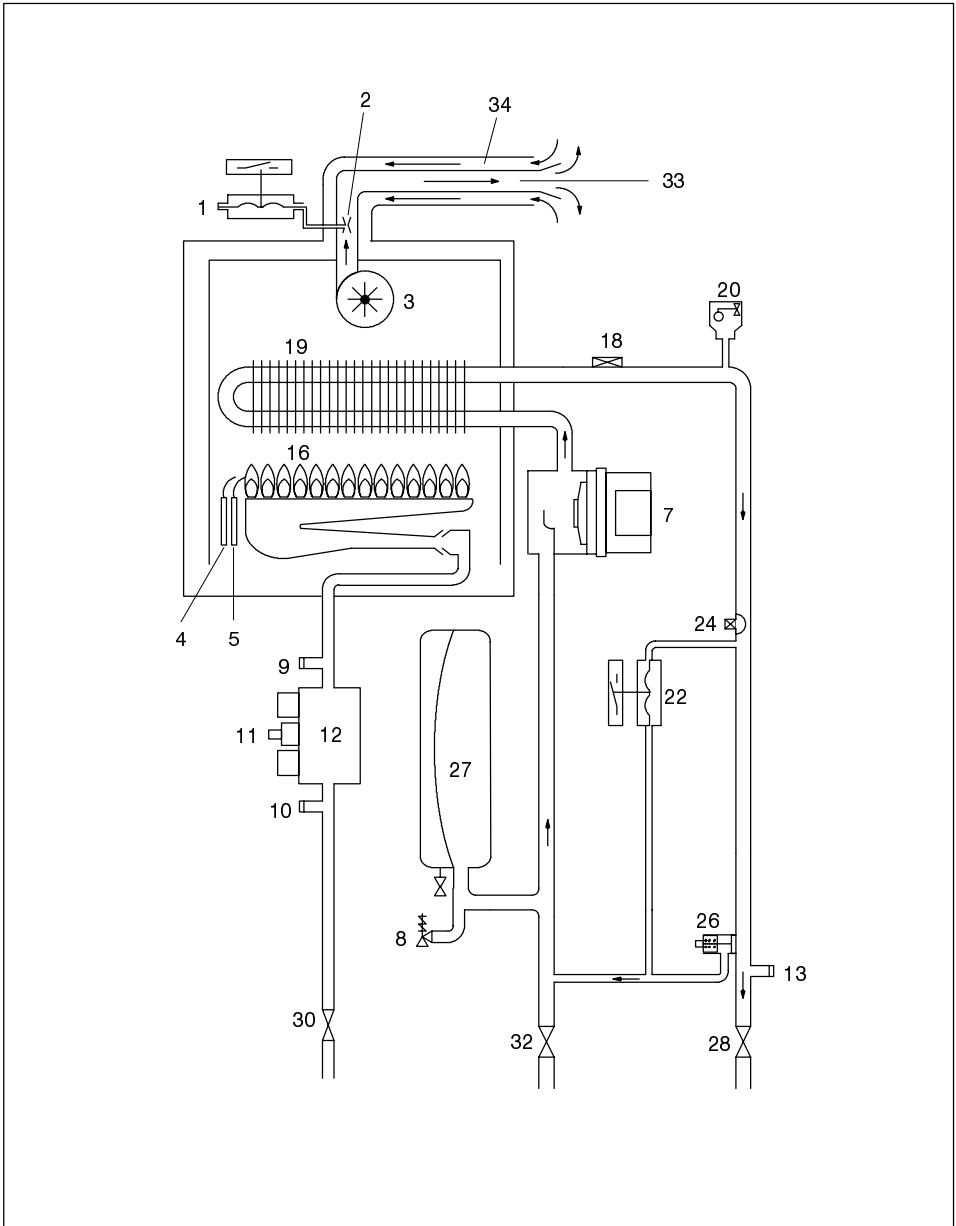

fig. 1.5 (key on page 3)

General

1.6 Technical data mod. 24S

Nominal heat input	kW	26,6
	BTU/h	90 754
Minimum heat input	kW	11,0
	BTU/h	37 530
Maximum useful output	kW	24,0
	BTU/h	81 883
Minimum useful output	kW	9,3
	BTU/h	31 730

Central heating		
Maximum temperature	°C	90
Minimum temperature	°C	35
Maximum pressure	kPa	300
	bar	3
Minimum pressure	kPa	30
	bar	0,3
Available head (in 1000 l/h)	kPa	26
	bar	0,26

Domestic hot water		
Maximum temperature	°C	55
Minimum temperature	°C	37
Maximum pressure	kPa	1 000
	bar	10
Minimum pressure	kPa	30
	bar	0,3
Flow rate		
minimum	l/min	2,5
30° rise	l/min	11,1
35° rise	l/min	9,5
40° rise	l/min	8,3

Injectors	
Natural G20	125
Butane G30	75
Propane G31	75

Gas supply pressures				
Gas		norm.	min	max
Natural G20	Pa	2 000	1 700	2 500
	mbar	20	17	25
Butane G30	Pa	2 900	2 000	3 500
	mbar	29	20	35
Propane G31	Pa	3 700	2 500	4 500
	mbar	37	25	45

Maximum gas pressures at the burner		
Natural G20	Pa	1 050
	mbar	10,5
Butane G30	Pa	2 680
	mbar	26,8
Propane G31	Pa	3 500
	mbar	35,0
Maximum gas rate		
Natural G20	m ³ /h	2,82
Butane G30	kg/h	2,09
Propane G31	kg/h	2,06

Minimum gas pressures at the burner		
Natural G20	Pa	130
	mbar	1,3
Butane G30	Pa	550
	mbar	5,5
Propane G31	Pa	700
	mbar	7,0
Minimum gas rate		
Natural G20	m ³ /h	1,16
Butane G30	kg/h	0,87
Propane G31	kg/h	0,85

G 20 p.c.i. 35,9 MJ/m³

G 30 p.c.i. 45,6 MJ/kg

G 31 p.c.i. 46,4 MJ/kg

1 mbar approximately equals 10 mm H₂O

General

Electrical Data		
Voltage	V~	220–240
Frequency	Hz	50
Power consumption	W	170
Protection degree		IP44
External fuse rating	A	3
Internal fuse rating	A	1,6 T

Flue design		
Minimum venturi pressure	mbar	–1,2
Flue pipe diameter		
Coaxial	mm	60/100
Twin split pipes	mm	80
Roof	mm	80/120
Nominal heat flow rate*	kW	26,6
Exhaust temperature*	°C	125
Smoke production*	kg/h	70
<i>* Values refer to tests with a 1 m chimney working at the nominal heat input</i>		

Other specifications		
Height	mm	800
Width	mm	450
Depth	mm	350
Weight	kg	47

General

1.7 Technical data mod. 28S

Nominal heat input	kW	31,1
	BTU/h	106 107
Minimum heat input	kW	13,0
	BTU/h	44 353
Maximum useful output	kW	28,0
	BTU/h	95 530
Minimum useful output	kW	11,0
	BTU/h	37530

Central heating		
Maximum temperature	°C	90
Minimum temperature	°C	35
Maximum pressure	kPa	300
	bar	3
Minimum pressure	kPa	30
	bar	0,3
Available head (in 1000 l/h)	kPa	26
	bar	0,26

Domestic hot water		
Maximum temperature	°C	55
Minimum temperature	°C	37
Maximum pressure	kPa	1 000
	bar	10
Minimum pressure	kPa	30
	bar	0,3
Flow rate		
minimum	l/min	2,5
30° rise	l/min	13,3
35° rise	l/min	11,4
40° rise	l/min	10,0

Injectors	
Natural G20	125
Butane G30	75
Propane G31	75

Gas supply pressures				
Gas		norm.	min	max
Natural G20	Pa	2 000	1 700	2 500
	mbar	20	17	25
Butane G30	Pa	2 900	2 000	3 500
	mbar	29	20	35
Propane G31	Pa	3 700	2 500	4 500
	mbar	37	25	45

Maximum pressures at the burner		
Natural G20	Pa	1 100
	mbar	11,0
Butane G30	Pa	2 680
	mbar	26,8
Propane G31	Pa	3 500
	mbar	35,0
Maximum gas rate		
Natural G20	m ³ /h	3,29
Butane G30	kg/h	2,45
Propane G31	kg/h	2,41

Minimum pressures at the burner		
Natural G20	Pa	140
	mbar	1,4
Butane G30	Pa	550
	mbar	5,5
Propane G31	Pa	700
	mbar	7,0
Minimum gas rate		
Natural G20	m ³ /h	1,37
Butane G30	kg/h	1,02
Propane G31	kg/h	1,00

G 20 p. c.i. 35,9 MJ/m³

G 30 p. c.i. 45,6 MJ/kg

G 31 p. c.i. 46,4 MJ/kg

1 mbar approximately equals 10 mm H₂O

General

Electrical Data		
Voltage	V~	220–240
Frequency	Hz	50
Power consumption	W	170
Protection degree		IP44
External fuse rating	A	3
Internal fuse rating	A	1,6 T

Flue design		
Minimum venturi pressure	mbar	– 1,4
Flue pipe diameter		
Coaxial	mm	60/100
Twin split pipes	mm	80
Roof	mm	80/120
Nominal heat flow rate*	kW	31,1
Exhaust temperature*	°C	120
Smoke production*	kg/h	80
<i>* Values refer to tests with a 1 m chimney working at the nominal heat input</i>		

Other specifications		
Height	mm	800
Width	mm	500
Depth	mm	350
Weight	kg	49

General

1.8 Technical data mod. 24SR

Nominal heat input	kW	26,6
	BTU/h	90 754
Minimum heat input	kW	11,0
	BTU/h	37 530
Maximum useful output	kW	24,0
	BTU/h	81 883
Minimum useful output	kW	9,3
	BTU/h	31 730

Central heating		
Maximum temperature	°C	90
Minimum temperature	°C	35
Maximum pressure	kPa	300
	bar	3
Minimum pressure	kPa	30
	bar	0,3
Available head (in 1000 l/h)	kPa	26
	bar	0,26

Gas supply pressures				
Gas		norm.	min	max
Natural G20	Pa	2 000	1 700	2 500
	mbar	20	17	25
Butane G30	Pa	2 900	2 000	3 500
	mbar	29	20	35
Propane G31	Pa	3 700	2 500	4 500
	mbar	37	25	45

Maximum gas pressures at the burner		
Natural G20	Pa	1 050
	mbar	10,5
Butane G30	Pa	2 680
	mbar	26,8
Propane G31	Pa	3 500
	mbar	35,0
Maximum gas rate		
Natural G20	m ³ /h	2,82
Butane G30	kg/h	2,09
Propane G31	kg/h	2,06

Minimum gas pressures at the burner		
Natural G20	Pa	130
	mbar	1,3
Butane G30	Pa	550
	mbar	5,5
Propane G31	Pa	700
	mbar	7,0
Minimum gas rate		
Natural G20	m ³ /h	1,16
Butane G30	kg/h	0,87
Propane G31	kg/h	0,85

Injectors	
Natural G20	125
Butane G30	75
Propane G31	75

G 20 p.c.i. 35,9 MJ/m³

G 30 p.c.i. 45,6 MJ/kg

G 31 p.c.i. 46,4 MJ/kg

1 mbar approximately equals 10 mm H₂O

General

Electrical Data		
Voltage	V ~	220–240
Frequency	Hz	50
Power consumption	W	170
Protection degree		IP44
External fuse rating	A	3
Internal fuse rating	A	1,6 T

Flue design		
Minimum venturi pressure	mbar	–1,2
Flue pipe diameter		
Coaxial – wall	mm	60/100
Twin split pipes	mm	80
Coaxial – roof	mm	80/120
Nominal heat flow rate*	kW	26,6
Exhaust temperature*	°C	125
Smoke production*	kg/h	70
<i>* Values refer to tests with a 1 m chimney working at the nominal heat input</i>		

Other specifications		
Height	mm	800
Width	mm	450
Depth	mm	350
Weight	kg	43

1.9 Hydraulic specifications

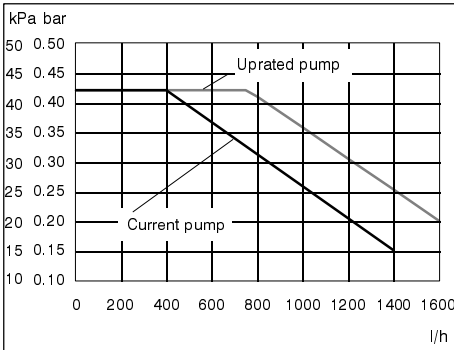

fig. 1.6

The hydraulic specifications in fig. 1.6 represent the pressure (available head of the central heating system) as a function of the flow rate.

The load loss due to the boiler has already been subtracted.

If necessary, it is possible to replace the current pump with an up-rated head one (supplied separately).

Output with thermostat cocks shut off

The boiler is fitted with an automatic by-pass valve (26 on page 3), which protects the primary heat exchanger.

In case of excessive reduction or total blockage of water circulation in the central heating system

owing to closure of the thermostatic valves or system component cocks, the by-pass valve ensures a minimum flow of water through the primary heat exchanger.

1.10 Expansion tank

The height difference between the pressure relief valve and the highest point in the system may be 7m at most.

For greater differences, increase the pre-load pressure in the expansion tank (27 on page 3) and the system, when cold, by 0.1 bar for each additional 1m.

Total capacity		8,0
Pre-load pressure	kPa	100
	bar	1,0
Available capacity		4,3
Maximum volume of water in the system *		150

tab. 1.1

* Where conditions are:

- Average maximum temperature of the system is 80°C
- Initial temperature when filling up the system is 10°C

For systems with volumes greater than 150l, an additional expansion tank must be provided.

This appliance must be installed by a competent person in accordance with the Gas Safety (Installation & Use) Regulations 1984.

2.1 Related documents

The installation of this appliance must be in accordance with the relevant requirements of the current Gas Safety (Installation & Use) Regulations, the Local Building Regulations, the current I. E. E. Wiring Regulations, the by-laws of the local water undertaking, and in Scotland, in accordance with the Building Standards (Scotland) Regulation. Health and safety document n° 635 "Electricity at work regs."

It should be in accordance also with the British Standard Codes of Practice:

2.2 Location of appliance

The appliance may be installed in any room or internal space, although particular attention is drawn to the requirements of the current I. E. E. Wiring Regulations, and in Scotland, the electrical provisions of the Building Regulations applicable in Scotland, with respect to the installation of the combined appliance in a room containing a bath or shower.

Where a room – sealed appliance is installed in a room containing a bath or shower, any electrical switch or appliance control, utilising mains electricity should be so situated that it cannot be touched by a person using the bath or shower.

The location must permit the provision of an adequate flue and termination.

For unusual locations special procedures may be necessary and BS 6798–1987 gives detailed guidance on this aspect.

A compartment used to enclose the appliance must be designed specifically for this purpose.

This appliance is not suitable for external installation.

2.3 Flue system

The provision for satisfactory flue termination must be made as described in BS 5440–1 1990.

The appliance must be installed so that the flue terminal is exposed to external air.

It must not be installed so that the terminal discharges into an other room or space as an out-house or lean-to. It is important that the position

of the terminal allows a free passage of air across at all times.

The terminal should be located with due regard for the damage or discoloration that might occur to building products in the vicinity.

In cold and/or humid weather water vapour may condense on leaving the flue terminal; the effect of such "steaming" must be considered.

The minimum acceptable spacing from the terminal to obstructions and ventilation openings are specified in fig. 2.1.

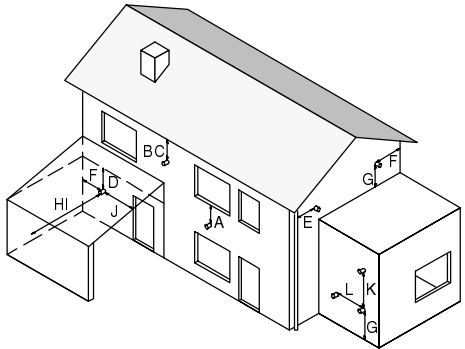

fig. 2.1

Terminal position	mm
A . Directly below a window or other opening	300
B . Below gutters, solid pipes or drain pipes	75
C . Below eaves	200
D . Below balconies or car port roof	650*
E . From vertical drain pipes and soil pipes	75
F . From internal or external corners	450*
G . Above ground or below balcony level	300
H . From a surface facing a terminal	600
I . From a terminal facing a terminal	1 200
J . From an opening in the car port (e.g. door, window) into dwelling	1 200
K . Vertically from a terminal in the same wall	1 500
L . Horizontally from a terminal in the same wall	300

* specific manufacturer requirements

2.4 Gas supply

Gas meter is connected to the service pipe by the local gas region or a local gas region contractor.

If the gas supply for the boiler serves other appliances ensure that an adequate supply is available both to the boiler and the other appliance when they are in use at the same time.

General requirements

Pipework must be of adequate size. Pipes of a smaller size than the boiler inlet connection should not be used.

Installation pipes should be fitted in accordance with BS 6891–1988 and the complete installation should be tested for soundness.

2.5 Air supply

The room in which the boiler is installed does not require a purpose provided air vent.

2.6 Ventilation

If installed in a cupboard or compartment, ventilation is also required for cooling.

Recommendations for air supply are detailed in BS 5440–2 1989.

2.7 Water circulation (central heating)

Detailed recommendations are given in BS 6798–1987 and BS 5449–1 1990; the following notes are given for general guidance.

Pipework

Copper tubing to BS EN 1057–1996 is recommended for water pipes. Jointing should be either with capillary soldered or with compression fittings.

Where possible pipes should have a gradient to ensure air is carried naturally to air release points and water flows naturally to drain taps.

The appliance has a built-in automatic air release valve anyway, it should be ensured as far as possible that the appliance heat exchanger is not a natural collecting point for air.

Except where providing useful heat, pipes should be insulated to prevent heat loss and to avoid freezing.

Particular attention should be paid to pipes passing through ventilated spaces in roofs and under floors.

By-pass

The appliance includes an automatic by-pass valve which protects the main heat exchanger in case of reduced or interrupted water circulation through the heating system due to the closing of

thermostatic valves or cock-type valves within the system.

The by-pass is calibrated to assure a minimum flow of 500–600 lts/hr through the main heat exchanger.

If you are installing a system that includes thermostatic radiator valves (TRV) and/or small bore (8–10 mm) it may be necessary to fit an external by-pass to facilitate correct operations of the boiler.

Air release points

These must be fitted at all high points where air will naturally collect and must be sited to facilitate complete fitting of the system.

The appliance has an integral sealed expansion vessel to accommodate the increase of water volume when the system is heated.

It can accept up to 7 lts (1,5 gals.) of expansion water.

If the heating circuit has an unusually high water content, calculate the total expansion and add additional sealed expansion vessel with adequate capacity.

Mains water feed: central heating

There must be no direct connection to the mains water supply even through a non return valve, without the approval of the Local Water Authority.

The boiler is designed to withstand a domestic water pressure of 10 bar.

Where it is likely that the mains domestic water pressure may exceed 5 bar, it is possible due to internal “water hammer” effects that the pressure within the domestic system can increase to a level in excess of the 10 bar limit.

If these circumstances it is therefore recommended that a 3 bar pressure reducing valve be fitted to the incoming mains water supply and a mini expansion vessel installed on the domestic circuit.

These devices will protect the boiler and the domestic system from damage due to excessive domestic water pressure.

Filling

A method for initially filling the system and replacing water lost during servicing must be provided

General requirements

and it must comply with local water authority regulations.

A possible method is shown in fig. 2.2.

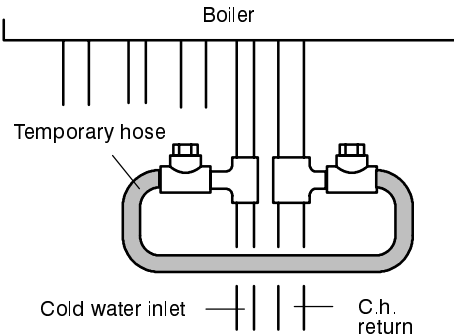

fig. 2.2

The installer should ensure that no leaks exist as frequent filling of the system could cause premature scaling of the heat exchanger.

2.8 Domestic water

The domestic water must be in accordance with the relevant recommendations of BS 5546–1990.

Copper tubing to BS EN 1057–1996 is recommended for water carrying pipework and must be used for pipework carrying potable water.

2.9 Electrical supply

Warning, this appliance must be earthed.

External wiring to the appliance must be carried out by a competent person and be in accordance with the current I. E. E. Regulations and local regulations which apply.

The boiler is supplied for connection to a 240 V~50 Hz supply. The supply must be fused at 3A.

The method of connection to the electricity supply must facilitate complete electrical isolation of the appliance by the use of a fused double pole isolator having a contact separation of at least 3 mm in all poles or alternatively, by the use of a 3A fused three pin plug and unswitched shuttered socket outlet both complying with BS 1363–1984.

The point of connection to the electricity supply must be readily accessible and adjacent to the appliance except where the appliance is installed in a bathroom this must be sited outside the bathroom.

3 INSTALLATION

3.1 Warnings

The use of gas appliances is subject to statutory control; it is essential to observe the current regulations and laws in force (see also chapter 2).

The appliance must discharge combustion products directly outside or into a suitable exhaust duct designed for this purpose.

Combustion products must be discharged using original flue kits only, since they are integral parts of the boiler.

For LPG, the appliance must also conform with the requirements of the distributors and comply with current Regulations and laws in force.

The safety relief valve must be connected to a suitable drain, or discharge in a safe manner.

The electrical wiring must conform with current Regulations, in particular:

- the boiler **must** be earthed using the correct bonding clamp.
- a fused spur isolation switch, with a gap of at least 3 mm between the contacts (fig. 3.1) must be installed near to the boiler. Refer to section 3.6 in this chapter for the electrical connections.

In no circumstances may the manufacturer be held responsible if the warnings and instructions contained in this manual should not have been complied with.

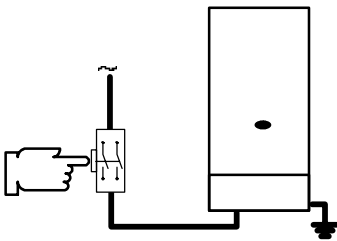

fig. 3.1

3.2 Precautions for installation

For the installation proceed as follows:

- The boiler must be fixed to a strong wall (fig. 3.2).

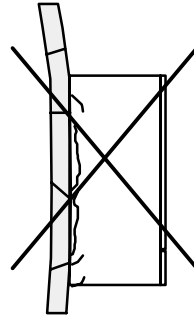
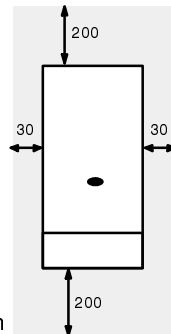

fig. 3.2

- The dimensions for the exhaust fume duct detailed in section 3.5, and the correct procedures for installing the duct, depicted in the instruction leaflet included with the flue kit, must be complied with during installation.
- To allow maintenance procedures it is necessary to leave the minimum gaps indicated in fig. 3.3.



All dimensions in mm

fig. 3.3

- When installing the boiler in a cupboard, cover or in an alcove, further than the distances defined in fig. 3.3, bear in mind that any possible obstacle in front of the boiler (the cupboard door for example) must be at such a distance as to allow a regular air flow; the upper part of the boiler must be freed from any obstacles.
- If the boiler is installed outside, cover the appliance to protect it against the elements and add some special anti-freeze (neutralised) to the central heating system. An optional anti-freeze kit is available to be fitted with this appliance.

Installation

- Before installing the boiler on an existing central heating system, flush it out thoroughly before fitting the boiler, so as to remove muddy deposits.
- It is advisable to equip the system with a sediment filter, or use a water –treatment product in the circulating water.

The latter option in particular, not only cleans out the system, but also has an anti –corrosive effect by promoting formation of a protective skin on metal surfaces and neutralising gases present in the water.

We recommend the use of a suitable universal inhibitory to protect the central heating system from corrosion.

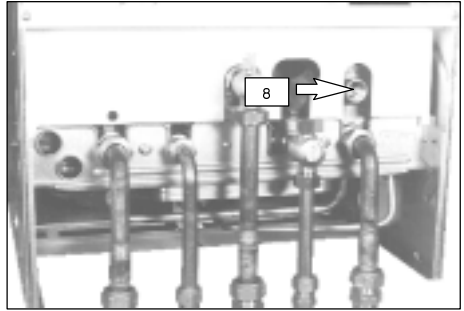

fig. 3.4

3.3 Installing the bracket

Dimensions and useful data for fitting the boiler are given on separate instructions included with the documents.

Precautions

Before mounting the bracket, check that the dimensions for fitting the exhaust fume duct are complied with (refer to the leaflet included with the flue kit, packed separately).

After mounting the bracket and before mounting the boiler, make sure the gas supply system is not leaking.

3.4 Mounting the boiler

- 1 Take the protective caps off the boiler pipework.
- 2 Thoroughly clean the taps.
- 3 Mount the boiler on its brackets.
- 4 Connect the pipework using the original seals supplied with the taps. You are recommended to tighten up the water and gas joints well.
- 5 Connect the pressure relief valve's outlet to a drain (8 in fig. 3.4) .

3.5 Fitting the exhaust fume duct

Refer to the leaflet included in the chosen kit, packed separately.

The following kits for connecting the boiler to the flue are available:

- 1 Exhaust fumes from wall and possible co –axial extensions \varnothing 60/100 mm
- 2 Vertical flanged extension \varnothing 60/100 mm
- 3 Connection for co –axial flue \varnothing 60/100 mm
- 4 Additional co –axial 90° or 45° elbow \varnothing 60/100 mm
- 5 Twin split pipes kit and possible extensions \varnothing 80 mm
- 6 Additional 90° or 45° elbow \varnothing 80 mm
- 7 Co –axial discharge to the roof and possible extensions \varnothing 80/120 mm

Kit 1 allows the flue to be fitted on any side of the boiler and it can **be shortened to a minimum** of 0.5 m. Use of extensions allows the exhaust fume duct to be lengthened. For all models the greatest total length is 2,65.

Kit 2 is an accessory that allows use of a section of vertical ducting from the boiler.

Installation

In fitting, only one type kit 2 can be used.

Kit 3 is an accessory that allows the fumes to be discharged through co-axial flues.

Each additional 90° elbow \varnothing 60/100 mm reduces the greatest length of the fume duct by 1 m, whilst those of 45° reduce it by 0.5 m.

Kit 5 is an accessory that allows separation of the air supply pipe from the pipe that discharges fumes in the flue.

Kit 6 is an accessory that allows changing the direction of the pipes of kit 5.

Each additional 90° elbow \varnothing 80 mm reduces the maximum length of the duct by 1 m, whilst those of 45° reduce it by 0.5 m.

Kit 7 allows venting of fumes directly to the roof.

The greatest total height is 5 m.

3.6 Electrical connections

Connection to the electricity supply

To reach the terminal block (A in fig. 3.5) turn over the control panel cover and remove the front panel of the case (see the section *maintenance*, section 6.2 in this manual).

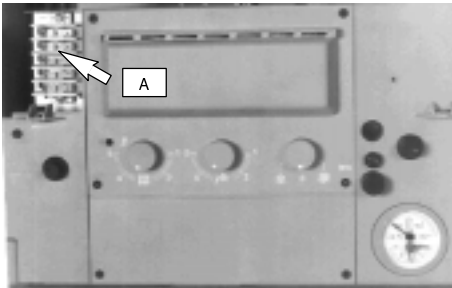

fig. 3.5

For the electrical connection of the boiler use electric wires which conform to the current regulations, with section cable **not less than 0,75 mm²**.

The cable must be long enough to permit turning over of the control panel towards you.

- 1 Connect the electrical supply cable coming from the fused spur isolation switch to the terminal block for the boiler (fig. 3.6) keeping the

same connections for the live (brown wire) and the neutral (blue wire).

External 3 A fuse or fused plug with same current rating is recommended.

Do not connect live wires to terminals to which the room thermostat must be connected.

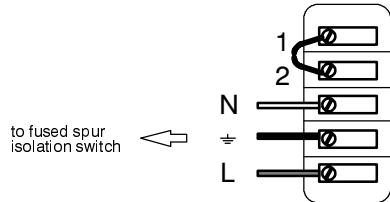

fig. 3.6

- 2 **Connect the earth wire (yellow/green).**

Connection of a room thermostat

The room thermostat must be connected to the terminal block situated next to the control panel.

When connecting any type of room thermostat, the jumper present between 1 and 2 must be removed.

Never connect live wires to terminals 1 and 2.

Connect the room thermostat as shown in one of the two following schemes (fig. 3.7 or fig. 3.8).

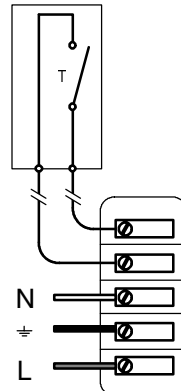

fig. 3.7 Two-wire thermostat. (240 V only).

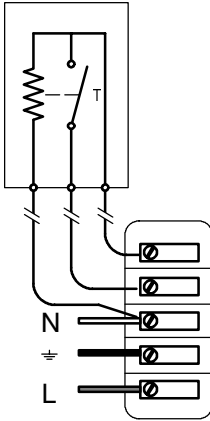

fig. 3.8 Two-wire thermostat with delay resistor (240V only)

3.7 Frost protection

It is not possible to fit a conventional froststat with this boiler.

However, you can introduce a suitable antifreeze solution into the system to protect the boiler from freeze conditions.

Moreover an optional antifreeze kit is available through your authorized dealer.

3.8 Overall dimensions

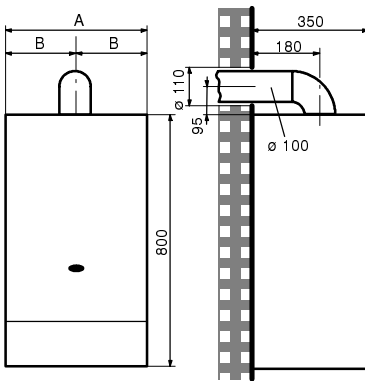

A = 450 for mod. 24
= 500 for mod. 28

B = 225 for mod. 24
= 250 for mod. 28

fig. 3.9

3.9 Joints

Functions	Pipe sizes (mm o.d.)
Gas	$\varnothing 22$
Central heating return	$\varnothing 22$
Central heating flow	$\varnothing 22$
Domestic cold water inlet*	$\varnothing 15$
Domestic hot water outlet*	$\varnothing 15$
Pressure relief valve	$\varnothing 15$ connector
* not present on c.h. only boilers	

tab. 3.1

The positions of the joints are given on separate instructions included with the documents.

4 COMMISSIONING

4.1 Electrical installation

Preliminary electrical system checks to ensure electrical safety shall be carried out by a competent person. I.e. polarity, earth continuity, resistance to earth and short circuit.

If a fault has occurred on appliance the fault finding procedure should be followed as specified under the servicing section of this document.

4.2 Gas supply installation

Inspect the entire installation including the gas meter, test for soundness and purge, all as described in BS 6891–1988;

Open the gas cock (30 in fig. 4.1) on the appliance and check the gas connector on the appliance for leaks.

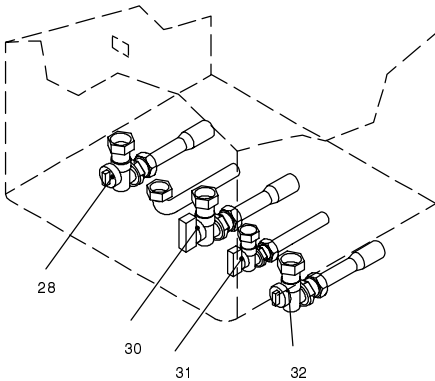

fig. 4.1

4.3 Filling the D.H.W. system

Close all hot water draw-off taps.

Open the cold water inlet cock.

Slowly open each draw-off tap and close it only when clear water, free of bubbles, flows out.

4.4 Initial filling of the system

Open central heating flow and return cocks.

Remove the front panel of the case (see the section *Access to and emptying the hydraulic circuits* in the service manual).

Unscrew the cap on the automatic air release valve (fig. 4.2) one full turn and leave open permanently;

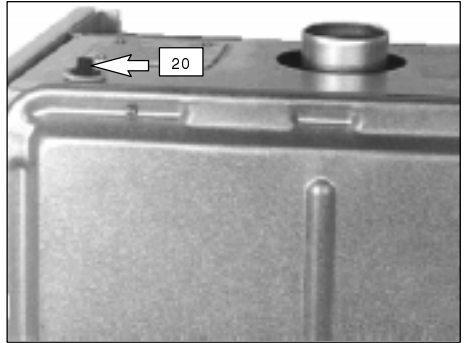

fig. 4.2

Gradually open stopcock at the filling point connection to the central heating system until water is heard to flow; do not open fully.

Open each radiator air release tap starting with the lower point and close it only when clear water, free of bubbles, flows out.

Purge the air from the pump by unscrewing the pump plug indicated (fig. 4.3); release the pump by turning the rotor in the direction indicated by the arrow on the information plate.

Close the pump plug.

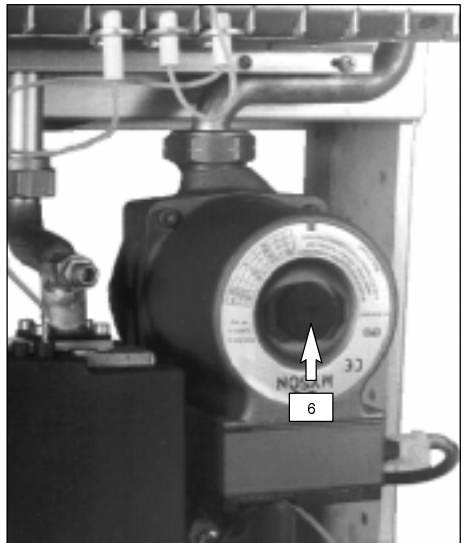

fig. 4.3

Commissioning

Continue filling the system. The actual reading should ideally be 1 bar and not less than 0,3 bar.

Close all air release valves on central heating system.

Inspect the system for water soundness and remedy any leaks discovered.

When the installation and filling are completed turn on the central heating system and run it until the temperature has reached the boiler operating temperature. The system must then be immediately flushed through.

The flushing procedure must be in line with BS7593: 1992 *Treatment of Water in Domestic Hot Water Central Heating Systems*.

This procedure must be repeated twice more.

During this operation we highly recommend the use of a central heating flushing detergent in the quantities as specified by the appropriate manufacturer, whose function it is to dissolve any foreign matter which may be in the system

The above operation could save the invalidation of your boilers guarantee and will also prevent problems which you may experience in the future if an inhibitory is not used.

4.5 Lighting the boiler

If external controls are fitted (e. g. Timeclock, room thermostat) ensure they "call for heat".

Switch on the mains electricity and turn the function switch as indicated in fig. 4.4A (combination boilers) or as in fig. 4.4B (central heating only boiler).

The green LED should be illuminated.

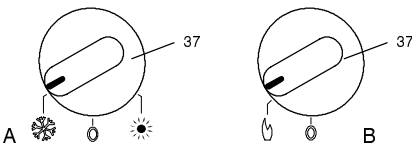

fig. 4.4

The boiler will now go through an ignition sequence and the burner will light.

If during the ignition attempt period the boiler fails to light, the full sequence control p.c.b. will go to lockout and the shut-down warning light will appear.

To reset the boiler depress the reset push button.

4.6 Checking the gas pressure at the burner

This boiler has been tested to the highest quality controls standards.

The maximum and minimum gas pressures are already pre-set during this quality control process.

It is therefore not normally necessary to undertake further adjustments however, a full explanation of pressure testing procedure is given below and the adjustment procedure is given in the service manual, *Gas Valve* section, if these operations are ever required.

Remove the front panel of the case and the control panel.

Loose the internal screw (9 in fig. 4.5) on the pressure test point for measuring outlet pressure at the gas valve and fit a pressure gauge using a hose;

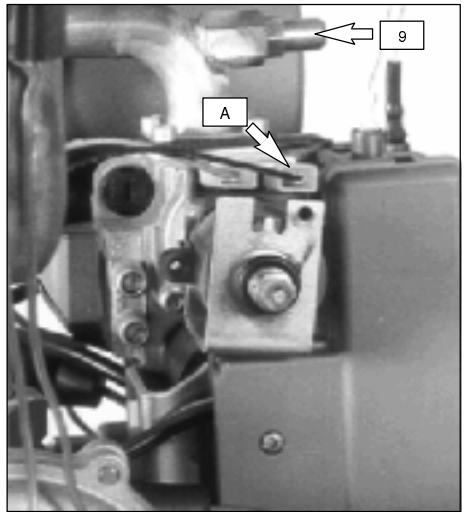

fig. 4.5

Switch on the boiler.

On the combined boilers open the hot water tap fully.

Set the d.h.w. temperature adjustment and the c.h. temperature adjustment to their maximum position.

Check the maximum gas pressure and compare the value on the manometer with the values indicated on the section *General – Technical data*

Commissioning

Check the maximum gas flow at the gas meter and compare with the values indicated on the section *General – Technical data*

turn off the electricity supply;

disconnect the gas modulator removing the connector A (fig. 4.5).

Switch on the boiler.

check the minimum gas pressure and compare the value on the manometer with the values indicated on the section *General – Technical data*

switch off the appliance and re-connect the line to the gas modulator;

close the domestic hot water cock.

4.7 Checking the flue system

The flue system should be visually checked for soundness. Check all clamps, gaskets and fixings are secure and tight.

To check the exhaust gas, remove the screw indicated and connect the analyzer to the exhaust gas sampling point (fig. 4.6).

Air intake
Sampling point

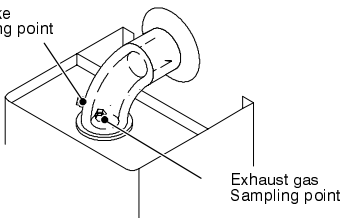

fig. 4.6

4.8 Checking the ignition device

With the burner on high flame close the gas cock, about 10 seconds after, the shut-down warning light must appear.

To reset the boiler depress the reset push button (41 in fig. 4.7)

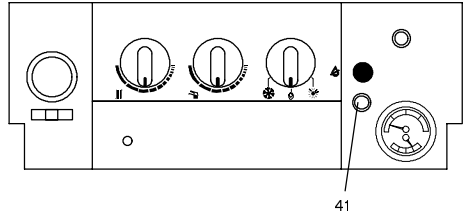

fig. 4.7

4.9 Adjusting the burner ignition

- 1 Turn off the boiler by means of the fused spur isolation switch provided with the appliance.
- 2 Make sure that the function switch (37) is set to the position in fig. 4.8A or fig. 4.8B and that the room thermostat, if fitted, is set to "heat demand".

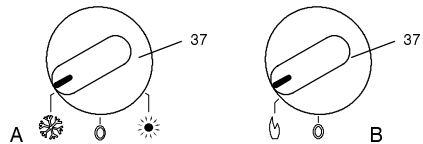

fig. 4.8

- 3 Unscrew the gas valve's outlet pressure tap (9 in fig. 4.5) and connect a pressure gauge.
- 4 Loosen the two screws (fig. 4.9) and remove the cover of the control panel.

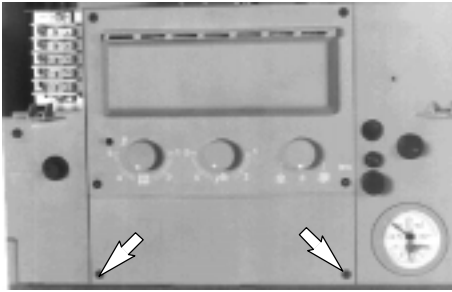

fig. 4.9

- 5 Turn on the boiler.
- 6 Check that the boiler lights up uniformly and adjust the flame height, if necessary. To adjust the ignition, set dip-switch "3" (fig. 4.10) to the OFF position and adjust potentiometer marked "ACC" with a screwdriver until correct lighting up is obtained (refer to tab. 4.1). Having finished this procedure, reset dip-switch "3" to the ON position.

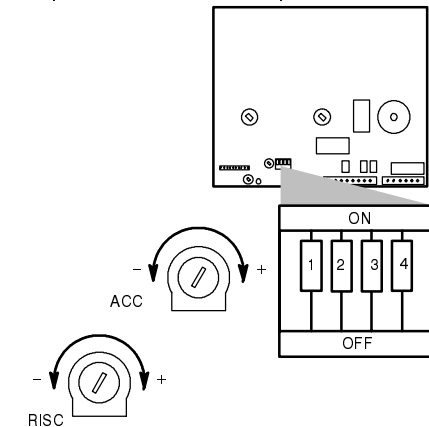

fig. 4.10

Ignition pressure		
Natural G20	Pa	600
	mbar	6,0
Butane G30	Pa	1 200
	mbar	12,0
Propane G31	Pa	1 300
	mbar	13,0

tab. 4.1

4.10 Adjustment of useful central heating output

Use a suitable screwdriver to turn the adjustment potentiometer marked "RISC" (fig. 4.10). Rotating the potentiometer anti-clockwise reduces the maximum supply current to the gas modulator device, and thus reduces the gas pressure to the burner.

Set the gas pressure according to the useful output chosen and adjust the gas flow rate according to fig. 4.11, fig. 4.12, and fig. 4.13.

Shut the cover of the control circuit board.

Close the pressure taps well and re-mount the case properly.

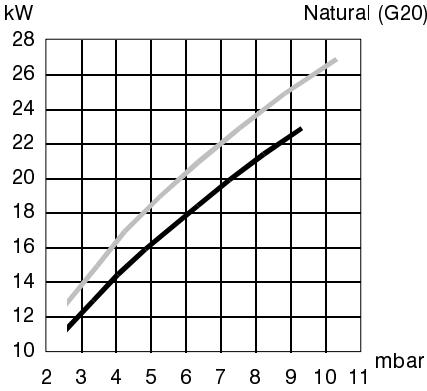

24S – 24SR
 28S

fig. 4.11

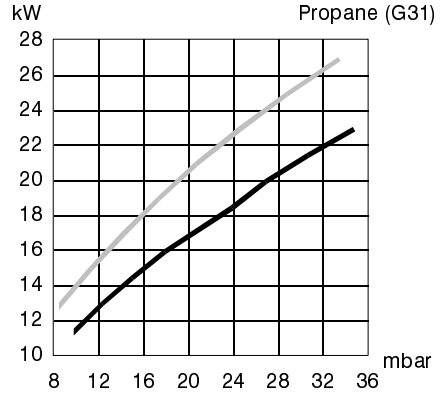

24S – 28SR
 28S

fig. 4.13

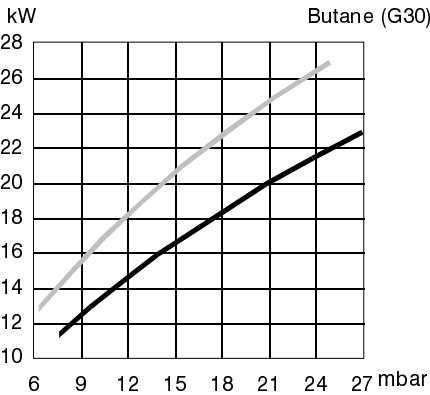

24S – 24SR
 28S

fig. 4.12

4.11 Instructing the user

Hand over the *User's instructions* supplied with the appliance and explain how to use the unit in both c.h. and d.h.w. modes;

take the User step by step through the lighting instructions;

show the User how to switch off the appliance quickly and indicate the position of the electric supply isolator;

explain the proper use and adjustment of all system controls; this will ensure the greatest possible fuel economy;

explain the function and use of the function switch;

explain and demonstrate the function of time and temperature controls (if fitted);

explain how to turn off the appliance for both short and long periods and advise on the precautions necessary to prevent damage should the appliance be inoperative when freezing conditions may occur;

finally, advise the User that, for continued safe and efficient operation, the appliance must be serviced by a competent person at least once a year.

5 GAS CONVERSION

5.1 Warnings

Procedures to adapt the boiler to the type of gas available **must be carried out** by a competent and responsible person.

Components used to adapt it to the type of gas available must be genuine parts only.

More detailed instructions, relating to the procedures for adapting the boiler to the type of gas available and subsequent calibration described below, are presented in the instruction leaflet for the conversion kit.

5.2 Procedures

- 1 Check that the gas cock (30 on page 3) fitted under the boiler is turned off and the appliance is not live.
- 2 Take off the front and left-hand side panels as shown in chapter *maintenance*, section 6.2 of this manual.
- 3 Take off the control panel.
- 4 Take off the removable side of the air-tight chamber.
- 5 Take the front panel of the combustion chamber off and remove the burner (16 on page 3).
- 6 Carry out the conversion for the type of gas, replacing the burner injectors (16 on page 3) correctly.
- 7 Re-assemble the burner (16 on page 3), the front panel of the combustion chamber and the removable side of the air-tight chamber.
- 8 Loosen the two screws (fig. 5.1) and remove the cover of the control panel.

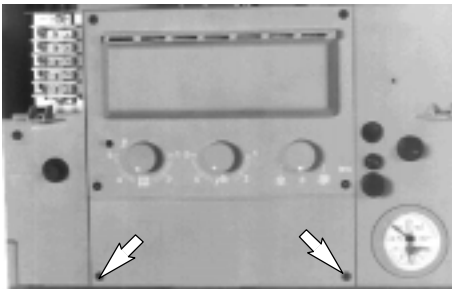

fig. 5.1

- 9 set correctly the dip-switch "2" (fig. 5.2) in accordance with the following table.

Gas supply	Position of dip-switch n. 2
Natural gas	On
L.P.G.	Off

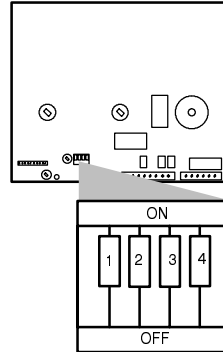

fig. 5.2

- 10 Calibrate the gas valve according to the instructions given in the leaflet included with the conversion kit.
- 11 Replace the the control circuit board cover, the front panel and the left-hand side panel of the case.
- 12 Stick a label indicating the type of gas, and the pressure level to which the appliance has been set, on the lower protection plate. The self-adhesive label is included with the conversion kit.

6 MAINTENANCE

6.1 Warnings

The procedures detailed in this chapter **must be carried out only by a professionally qualified person**. Thus you are advised to contact an Authorised Service Centre.

For efficient and continuous operation of the boiler you are advised to have, at least once a year, maintenance and cleaning done by an Approved Service Centre engineer.

Isolate the appliance from the electricity supply by turning off the fused spur isolation switch fitted with the appliance and **turn off the gas cock**, before carrying out any procedures, whatsoever, for cleaning, maintenance, opening or dismantling boiler panels.

6.2 Dismantling the external panels

Front panel

- 1 Loosen the two screws "A". Bring the base of the panel far from the boiler and lift it, freeing it from the top hooks (fig. 6.1)

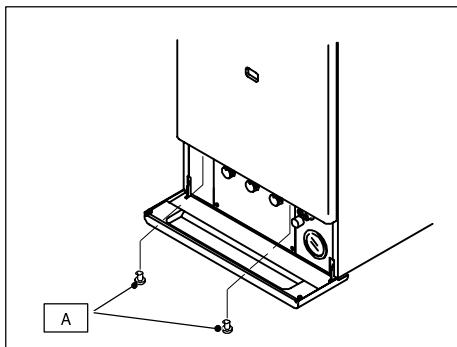

fig. 6.1

Side panels

- 2 Loosen the two screws "A" (fig. 6.2) and lift the panels freeing them from the side hooks.

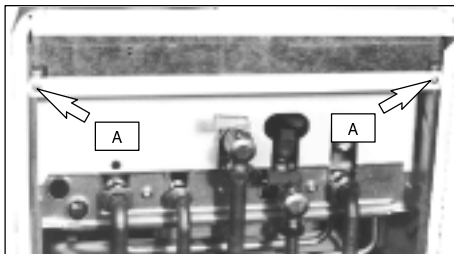

fig. 6.2

Lower protection plate

- 3 Slacken off screws "A" (fig. 6.2) and remove the lower protection plate.

6.3 Emptying the domestic hot water system (Combination boilers only)

- 1 Turn off the dhw inlet cock (31 in fig. 6.3) and turn on the "utilities" cocks.

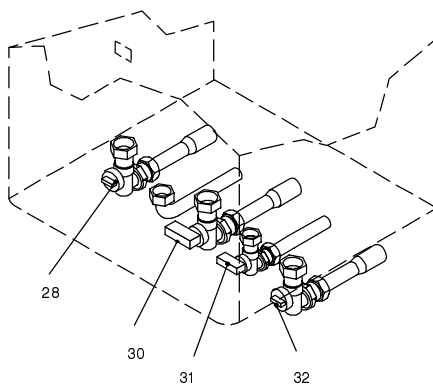

fig. 6.3

6.4 Emptying the central heating system

- 1 Turn off the c.h. cocks (28, 32 in fig. 6.3).
- 2 Turn off the central heating drain cock (13 in fig. 6.4).
- 3 To facilitate the downflow of water, remove the front panel, also remove the sealed chamber lid and loosen the nut of the automatic air bleed valve.

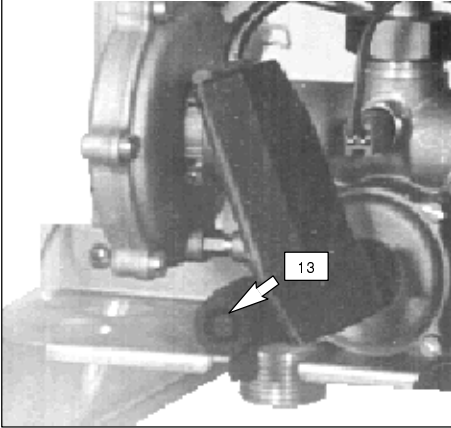

fig. 6.4

- 4 Tight it again once the emptying has been completed.

6.5 Cleaning the primary heat exchanger

Take off the front of the case, then the removable side of the air-tight chamber and the front panel of the combustion chamber.

If you notice dirt on the fins of the primary heat exchanger (19 on page 3), cover the sloping surfaces of the burner (16 on page 3) entirely in a protective layer (sheets of newspaper or similar). Brush out the primary heat exchanger (19 on page 3) with a bristle paintbrush.

6.6 Checking the pressurisation in the expansion tank

Empty the central heating system as described in section 6.4 of this chapter and check that the pressure in the expansion tank is not less than 1 bar.

If the pressure should be lower, take steps to correct the pressure level.

6.7 Cleaning the burner

The sloping and multi-gas type burner (16 on page 3) does not need special maintenance, but it is sufficient to dust it with a bristle paintbrush.

6.8 Checking the exhaust duct

Have the integrity of the exhaust fume duct (33 on page 3) air duct (34 on page 3), checked periodically, the venturi (2 on page 3) cleaned and the efficiency of the exhaust safety circuit checked at least once a year.

For all the above maintenance operations it is advisable to call an approved Service Engineer.



17962.0400.2 9802

BIASI U.K Ltd
Unit 32/33, Planetary Road
Industrial Estate, Neachelles Lane
Willenhall, Wolverhampton WV13 3XB