

# OpenTherm

## Programmable room thermostat

### Installation & Operating Instructions

THESE INSTRUCTIONS  
TO BE RETAINED  
BY USER

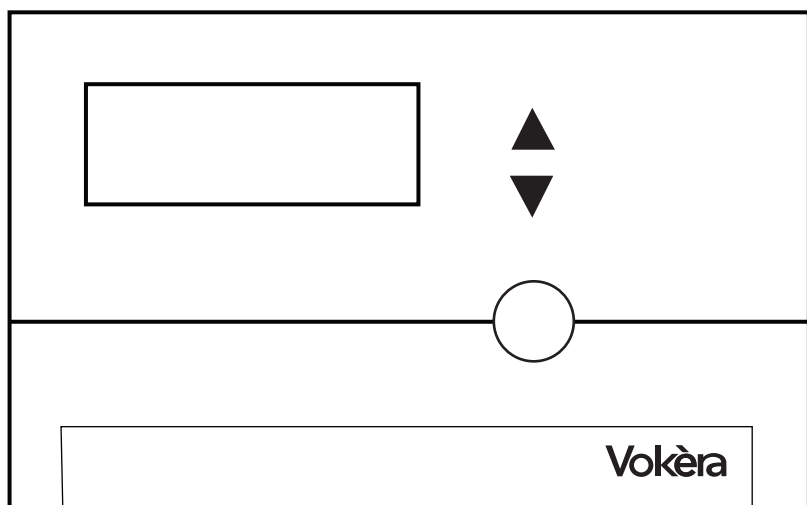

## SPECIFIED USE

This combined control RFT & OTR (transmitter & receiver) is for use only with the following Vokera appliances:

- Unica HE
- Linea 28HE\*,32HE\*,36HE\*
- Mynute HE
- Mynute VHE

\*Requires wiring kit

## WARNING

This combined control must not be used or connected to any other appliance. This apparatus must only be installed by a competent person.

This control is comprised of a battery operated transmitter (RFT) and a wired receiver (OTR); the transmitter can be located within any heated area\* of the dwelling whilst the receiver must be connected to the boiler\*\*.

\* The transmitter can be located up to 25-metres from the receiver and must be located in an area that is directly heated by the boiler

\*\*The receiver must be connected to the boiler's Open-therm connections (see installation booklet) and be sited no more than 1-metre from the boiler

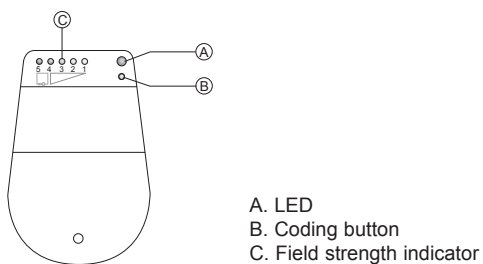

## 1.0 INSTALLATION OF THE RECEIVER

These instructions must be read in conjunction with the appliance installation booklet.

Isolate the appliance from the electrical supply and remove the appliance casing. Locate and remove the PCB cover that contains the Open-therm terminals.

Remove the cover from the receiver and using a suitable piece of 2-core flex, connect the receiver to the Open-therm terminals of the appliance and refit the PCB cover and appliance casing.

## NOTE

The receiver can be mounted on a wall adjacent to the appliance.

## 2.0 PAIRING/CODING OF THE RECEIVER WITH THE TRANSMITTER

The combined control (transmitter & receiver) are coded and paired during the final production test; it's therefore not necessary to pair the unit at the point of installation or first-use. However if the transmitter/receiver has been reset or either component (transmitter/receiver) is to be used with a replacement/different unit, it will be necessary to re-code and pair the new combination.

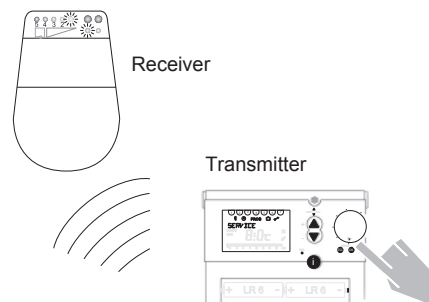

Ensure the transmitter has been set/left in the coding mode (menu > service > coding > OK) and press button B on the receiver for approximately 5-seconds, LED A will light up briefly. Press ESC to escape from the coding mode.

To check that the coding is active or has been successful, go back into the coding mode for the transmitter (menu > service > coding), when you press OK the LED A will light up briefly to confirm that the receiver is now paired with the transmitter.

### 2.1 SIGNAL STRENGTH TEST

To check that the receiver is picking up a signal from the transmitter, enter into the menu: Menu > Service > Test HF.

A test signal will be sent for a period of 15-minutes from the transmitter to the receiver every 5-seconds. In turn, at least one signal strength indicator LED should light up; the strength of signal is indicated by the quantity of LED's that are illuminated.

Place the transmitter in a room or location that enables optimum signalling.  
To cancel the signal strength test, press ESC at any time.

### 2.2 CODING RESET

Should it be necessary to cancel or reset the current coding/pairing of the receiver with a respective transmitter, press button B for

10-seconds. The LED will illuminate for 3-seconds before going out.

### 3.0 TRANSMITTER OVERVIEW AND SETUP

The transmitter (RFT) is powered by 2 x AA batteries and these should last approximately 1.5-years.

The transmitter can be wall-mounted or can left on a desktop or table-top using the free-standing support (supplied).

### 3.1 INSERTING/REPLACING BATERIES

Remove the battery compartment cover and insert 2 x AA batteries within 10-minutes to ensure any memorised program or setting is maintained.

### 3.2 INITIAL SETUP

The transmitter (RFT) and receiver (OTR) have been coded and paired with each other during the final production test at the factory. However if either of the components have been reset or is a replacement unit it will be necessary to code and pair the RFT with the OTR (see section 2.0)

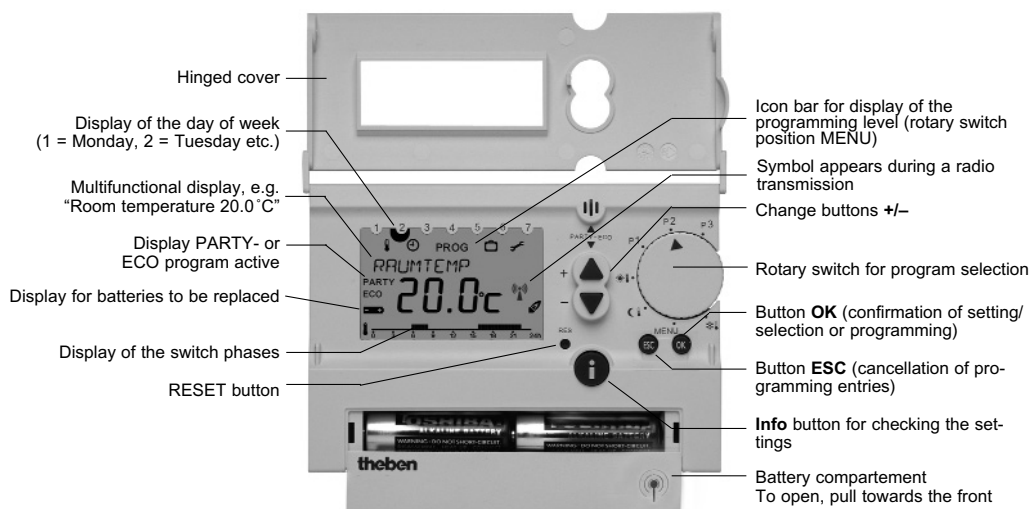

Once the batteries have been inserted into the battery compartment and the OTR has been connected to the boiler, the transmitter can be mounted/located and programmed for use.

### 3.3 MOUNTING/LOCATION

The RFT can be mounted on any wall within the dwelling or can be table/desk located using the stand provided.

To ensure optimum performance, it's preferable to carry out a signal strength test (section 2.1) before deciding on a final location. Ideally, for wall mounted applications, the unit should be positioned 1.5-metres from the floor level.

Avoid areas such as near or above fireplaces, televisions, windows, or radiators that provide artificial room temperature conditions.

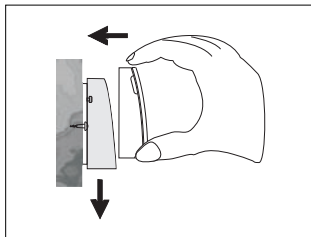

Wall mounting

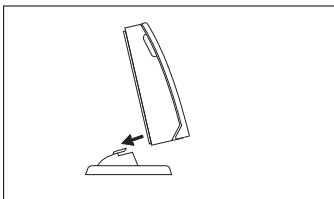

Free-standing

For wall-mounting applications, detach the back-plate from the RFT by inserting a small flat bladed screwdriver on the bottom underside of the unit.

Use a combination of suitable mounting holes on the back-plate to secure the back-

plate to the wall at a height of 1.5-metres from the floor.

### 3.4 MENUS AND SUB-MENUS

Once the unit is powered via the batteries, the display is active and the default settings are enabled.

#### PROGRAMMING PROCEDURE

Rotate the program selector to the MENU position, using the ▲▼ buttons you can scroll through the main menu:

- TARGET TEMP
- SERVICE
- HOLIDAY
- PROGRAM P3
- CLOCK/DATE

#### 3.4.1 TARGET TEMP MENU

Using the programming procedure, scroll through the main menu until TARGET TEMP is displayed; press the OK button to select the sub menu:

- COMFORT – temperature required when the heating is ON
- LOWER – temperature required when the heating is OFF
- FROST – setting level when the program selector is in the frost protection mode or the HOLIDAY function has been enabled

Use the ▲▼ buttons to select the desired temperature/s and press OK to confirm or ESC to cancel any changes.

#### 3.4.2 SERVICE MENU

Using the programming procedure, scroll through the main menu until SERVICE is displayed; press the OK button to select the sub menu; use the ▲▼ buttons to select the desired function:

- HW IMMEDIATE
- CODING
- TEST RF
- CONTROL
- WALL COMP
- OPTIMISATION
- DISPLAY
- HOT WATER
- LANGUAGE

See section 5.0 for more detailed information on the SERVICE functions.

### 3.4.3 HOLIDAY MENU

Using the programming procedure, scroll through the main menu until HOLIDAY is displayed; press the OK button to select the sub menu; use the ▲▼ buttons to program:

- START HOLIDAY – the date and time when you want the holiday period to begin
- END HOLIDAY – the date and time when you want the holiday period to end
- FROST SETTING – the operating temperature that is active during the holiday period
- CHECK – used to check the above programmed details
- CLEAR – used to clear or cancel the holiday settings or activity.

### 3.4.4 PROGRAM P3 MENU

Using the programming procedure, scroll through the main menu until PROGRAM P3 is displayed; press the OK button to select the sub menu; use the ▲▼ buttons to select the desired function:

- HEATING – programme your own individual ON/OFF times for the central heating
- HOT WATER – programme your own individual ON/OFF times for hot water

See section 4.0 for more detailed information on the PROGRAM P3 functions.

### 3.4.5 CLOCK/DATE MENU

Using the programming procedure, scroll through the main menu until CLOCK/DATE is displayed; press the OK button to change/review; use the ▲▼ buttons to change/amend the date and time as follows:

With the ESC button you can always return to the previous programming step in order to adjust a setting.

1. The display shows the time setting.



2. Set the current time with the buttons ▲ and ▼:

Set the hour and confirm with the OK button.



Set the minutes and confirm with the OK button.

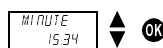

3. The display changes automatically to the date setting.

Set the year, month and date one after the other. Confirm each setting with the OK button. The display changes automatically.

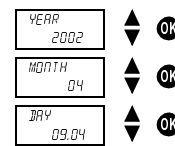

### 3.5 PROGRAM SELECTOR

The selector can be positioned to enable the various modes of operation as well as the MENU position.

P3 – move the program selector to this position if you want to use your own specific programme for heating and hot water (see 4.0)  
 P2 – is a fixed programme; comfort temperature is active during Mon - Fri 6 - 8 am, 4 - 10 pm, and Sat - Sun 7 am - 11 pm. The lower temperature is active at all other times  
 P1 – is a fixed programme; comfort temperature is active during Mon - Fri 6 am - 10 pm, and Sat - Sun 7 am - 11 pm. The lower temperature is active at all other times

☼ ↓ - Comfort temperature setting: when the selector is in this position, the room temperature is permanently maintained at the comfort value

☼ ↓ - Lower temperature setting: when the selector is in this position, the room temperature is permanently maintained at the lower value

☼ ↓ - Frost protection setting: when the selector is in this position, the room temperature is permanently maintained at the frost protection value

### 3.6 INFO BUTTON

With the INFO button, you can check/display the following:

- Current room temperature
- Target room temperature
- Required hot water temperature
- Date and time
- Current operating mode
- Current display mode
- Switching times of the current program (only visible when the hinged cover is open)

### 3.7 TEMPORARY ADJUSTMENT OF THE TARGET TEMPERATURE

By using the ▲▼ buttons, you can temporarily alter the target temperature (up or down) until the next temporary change, e.g. from Comfort to lower.

- Press either of the ▲▼ buttons to display the current target temperature
- Continually press the ▲ button to increase the target temperature, or the ▼ button to decrease the target temperature until the required temporary value is displayed
- After 3-seconds, the display will automatically return to its original state and the thermostat will regulate to the new temporary value
- When the selector is in either of the permanent Comfort – Lower – Frost settings, the temporary target temperature is maintained until the selector is moved or a new temporary value is chosen.

### 3.8 PARTY/ECO PROGRAM

With the party/eco function you can temporarily change the set temperature profile up to a maximum period of 23-hours and 50-minutes.

- Press and hold both ▲▼ buttons simultaneously for 2-seconds
- The display changes and shows PERIOD and a flashing clock; within the 3-seconds press either ▲▼ button to move the display to the required time period (increments of 10-minutes).
- After 3-seconds, the display changes and shows flashing text COMFORT or LOWER.

If necessary, use the ▲▼ buttons to change the display to show COMFORT or LOWER in order to select the preferred temperature regime for the set period.

- The display changes automatically after 3-seconds to show the desired temperature regime ECO (lower) or PARTY (comfort); the party/eco program is now active for the period selected.
- The party/eco function can be cancelled by pressing and holding both ▲▼ buttons simultaneously for 2-seconds and then wait for 3-seconds; the display will revert to normal and the party or eco function will be cancelled.

### 4.0 PROGRAMMING

To program bespoke time settings for the heating and hot water proceed as follows:

#### STEP-1:

Rotate the selector to the MENU setting and select PROGRAM P3 and then select NEW from the sub-menu

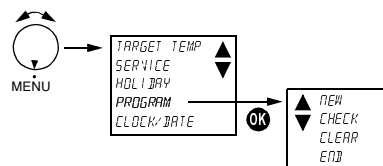

#### STEP-2: Select the day or group of days that are to be programmed and then select the time periods

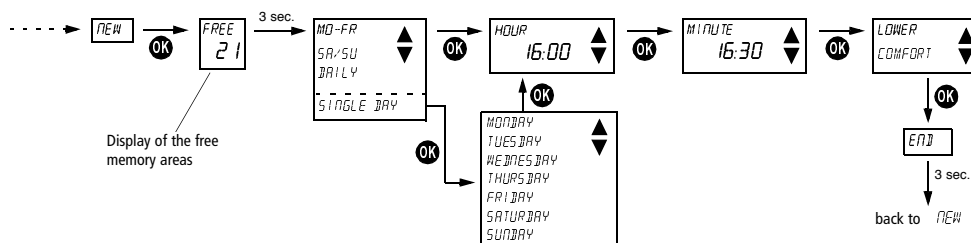

**STEP-3: You can confirm time settings via the sub-menu**

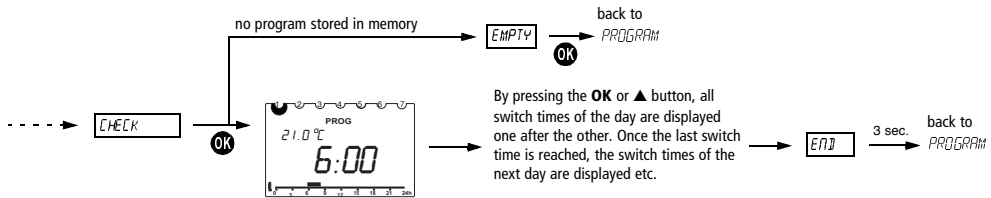

**STEP-4: You can clear time settings via the sub-menu**

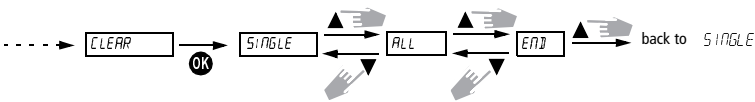

**Displaying individual switch times and clearing them**

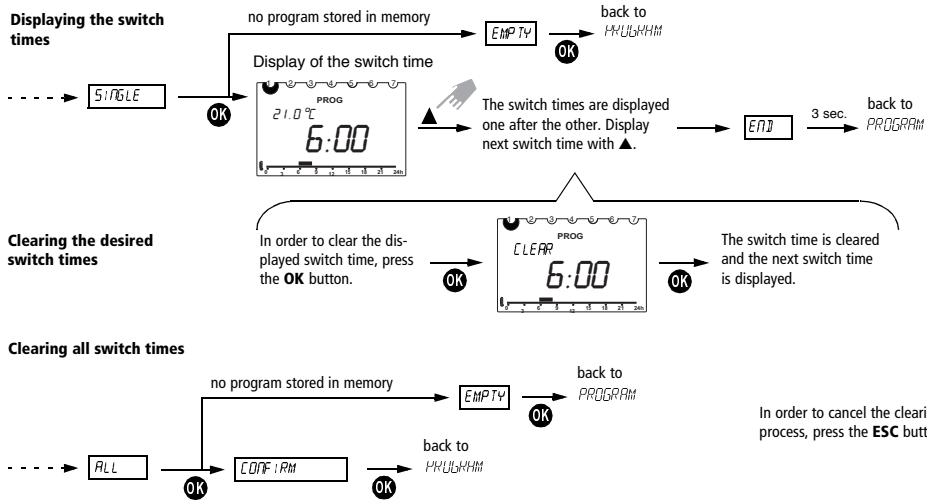

## 5.0 SERVICE MENU

Using the programming procedure, scroll through the main menu until SERVICE is displayed; press the OK button to select the sub menu; use the ▲▼ buttons to select the desired function:

- HW IMMEDIATE
- CODING
- TEST RF
- CONTROL
- WALL COMP
- OPTIMISATION
- DISPLAY
- HOT WATER
- LANGUAGE

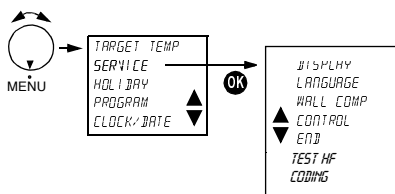

### 5.1 HW IMMEDIATE

With this function, household water can be heated and enabled once, regardless of the times set in the program.



Setting with the buttons ▲ or ▼. Confirm the value with OK (cancel with ESC).

### 5.2 CODING

This function is used to 'pair' the transmitter with the receiver. Transmitter and receiver are already 'paired' at the factory so during normal installation and use, it's not necessary to carry out this function; see section 2 for more detailed information.

### 5.3 TEST RF

See section 2.1

## 5.4 CONTROL

Characteristics of the PD controller

With suitable heating systems the PD controller is characterized by a short setting time, scarce maximum overshooting and therefore a high control accuracy.

Characteristics of a hysteresis controller

With over or under engineered heating systems a hysteresis controller is characterized by scarce shift frequency and small temperature deviations.

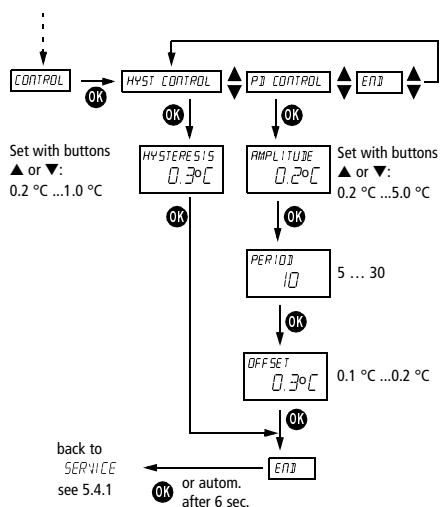

### 5.5 WALL COMP

If required, the transmitter can be calibrated to account for temperature differentials between the mounting location (wall) and the ambient room temperature, e.g. if the transmitter is located on a wall that is an external wall of the dwelling.

Example: The difference between the measured and the controlled temperature is 2 °C, i.e. the room temperature is regulated 2 °C too high: Offset value -2 °C.

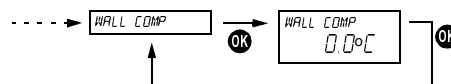

Offset value adjustable from  $-3\text{ }^{\circ}\text{C}$  ...  $+3\text{ }^{\circ}\text{C}$ .  
Setting with ▲ or ▼. Confirm the value with OK. Cancel with ESC.

## 5.6 OPTIMISATION

The optimal start function – when enabled – starts the boiler (prior to the timed ON period) in order to have the room at the comfort temperature level when the Timed ON period begins.

The optimal start function can be set from 0-minutes (optimisation is disabled) up to 60-minutes. The unit measures the temperature differential between the actual (room) temperature and the target – comfort – temperature and starts the boiler the set period of minutes for each degree of differential that exists.

Example:

- Optimisation is set at 10-minutes
- ON (comfort) period begins at 6:00 am
- Temperature differential (between actual  $18\text{ }^{\circ}\text{C}$  and comfort setting  $21\text{ }^{\circ}\text{C}$ ) is 3-degrees
- Therefore  $3 \times 10 = 30$ -minutes
- Boiler is started at 5:30 am to ensure room is at comfort level for 6:00 am

## 5.7 DISPLAY

The normal display can be changed to show different information.

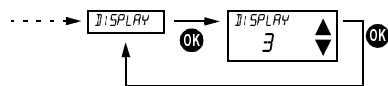

Select the display type with the button ▲ or ▼. Confirm with the OK button.

Cancel with ESC.

Note: The factory setting is highlighted grey in the table.

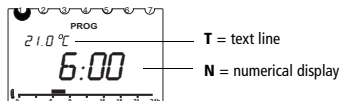

	Rotary switch position P1, P2 or P3					Rotary switch position ⬆️ ⬇️ ⬇️ ⬆️ ⬆️				
	Display type					Display type				
	1	2	3	4	5	1	2	3	4	5
Time	T	T			N					N
Target temp.		N	N	T			N	N		
Actual temp.	N			N	T	N			N	
Program name						T	T	T	T	T

Table: Overview of the information shown in the display for different displays types.

## 5.8 HOT WATER

You can choose to have the unit manage the timed settings of the hot water function, or both time settings and outlet temperature.

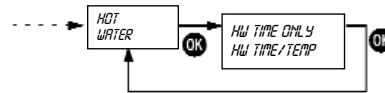

## 5.9 LANGUAGE

The following languages can be selected via the LANGUAGE function:

- English
- German (Deutsch)
- Italian (Italiano)
- Portugese (Portugues)
- Dutch (NL)
- Spanish (Espanol)
- French (Francais)

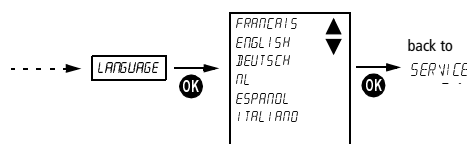

Select the language with the buttons ▲ or ▼. Confirm with the OK button.

Cancel with ESC.

## 6.0 TIME – DATE – SUMMER/WINTER TIME

See example below

## 7.0 RESET

Reset button >

Time: 12:00

Date: reset

Holiday program: clear

(See 4.0 Step 4 to clear all programs)

## 8.0 TECHNICAL SPECIFICATION

Control type: RS type 1 acc. to  
EN 60730-1:1991

Accuracy:  $\pm 1$  sec. per day at 20 °C

Control accuracy:  $\pm 0.2$  K

Temperature meas. range:  
0 °C to 50 °C,  
resolution 0.1 °C

Temperature setting range:  
6 °C to 30 °C in increments  
of 0.2 °C

Control period: 5 to 30 min. (PD control)

Control lock-in range:

$\pm 0.2$  K to  $\pm 5$  K (PD control)

Switching hysteresis:

$\pm 0.2$  K to  $\pm 1.0$  K  
(hysteresis control)

Memory spaces: 32 temperature changes,  
programmable for Mo-Fr,  
Sa-Su, each day or for  
individual days

Class of protection:

III according to EN 60730-1

Type of enclosure:

IP 20 according to  
EN 60529-1

Batteries: 2 x alkaline batteries 1.5 V,  
type AA

Power reserve during battery emplacement:  
10 minutes

### Time/Date and Summer/Winter Time

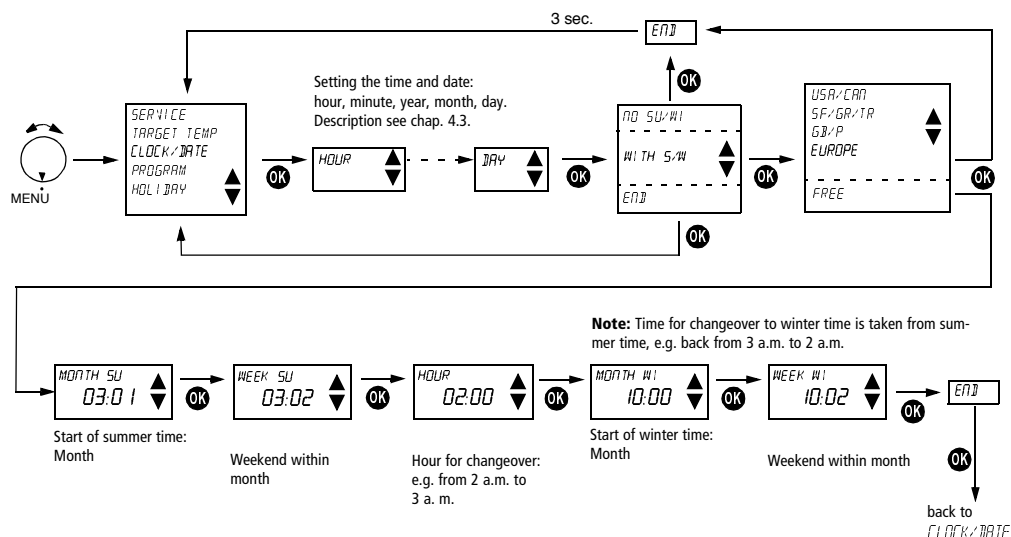

## **9.0 MAINTENANCE**

With the exception of a regular replacement of the batteries for the transmitter, the room thermostats are maintenance-free.

Only clean the device with a dry or slightly damp, soft and lint-free cloth. The interior of the device must remain free from water.

Replace the two batteries at regular intervals every 1.5 years. Only use new 1.5 V batteries of the type AA, Alkaline. Never mix old and new batteries, as old batteries can leak.

## **10.0 DISPOSAL**

### Disposal of Batteries

Used batteries must be disposed of according to the national regulations with regard to the environment (e.g. at special battery collection outlets). Never throw used batteries out with your usual rubbish.

### Disposal of the Device

At the end of its life, the room thermostat must be dismantled professionally and disposed of according to the national regulations with regard to the environment.

In case of doubts, please contact the manufacturer's representative in your country.



**Registered address:**

Vokèra Ltd  
Borderlake House  
Unit 7 Riverside Industrial Estate  
London Colney  
Herts AL2 1HG

**[enquiries@vokera.co.uk](mailto:enquiries@vokera.co.uk)**

**[www.vokera.co.uk](http://www.vokera.co.uk)**  
**[www.vokera.ie](http://www.vokera.ie)**

***Sales, General Enquires***

**T 0844 391 099**  
**F 0844 391 0998**

Vokèra Ireland  
West Court, Callan  
Co Kilkenny  
**T 056 7755057**  
**F 056 7755060**

Vokèra Limited reserve the right to change  
specification without prior notice  
Consumers statutory rights are not affected.

A Riello Group Company.  
Company Reg No: 1047779